



victron energie

**USER MANUAL
GEBRUIKSAANWIJZING
GEBRAUCHSANWEISUNG
MODE D'EMPLOI**

Phoenix Combi 12/1000/50
Phoenix Combi 12/1600/75
Phoenix Combi 24/1200/30
Phoenix Combi 24/2000/50



SECTIONS	page
English	3
Nederlands	47
Deutsch	91
Français	135



Copyrights © 1999, 2000 Victron Energie B.V.
All Rights Reserved

This publication or parts thereof, may not be reproduced in any form, by any method, for any purpose.

VICTRON ENERGIE B.V. MAKES NO WARRANTY, EITHER EXPRESSED OR IMPLIED, INCLUDING BUT NOT LIMITED TO ANY IMPLIED WARRANTIES OF MERCHANTABILITY OR FITNESS FOR A PARTICULAR PURPOSE, REGARDING THESE VICTRON ENERGIE PRODUCTS AND MAKES SUCH VICTRON ENERGIE PRODUCTS AVAILABLE SOLELY ON AN "AS – IS" BASIS.

IN NO EVENT SHALL VICTRON ENERGIE B.V. BE LIABLE TO ANYONE FOR SPECIAL, COLLATERAL, INCIDENTAL, OR CONSEQUENTIAL DAMAGES IN CONNECTION WITH OR ARISING OUT OF PURCHASE OR USE OF THESE VICTRON ENERGIE PRODUCTS. THE SOLE AND EXCLUSIVE LIABILITY TO VICTRON ENERGIE B.V., REGARDLESS OF THE FORM OF ACTION, SHALL NOT EXCEED THE PURCHASE PRICE OF THE VICTRON ENERGIE PRODUCTS DESCRIBED HEREIN.

For conditions of use and permission to use this manual for publication in other than the English language, contact Victron Energie B.V.

Victron Energie B.V. reserves the right to revise and improve its products as it sees fit. This publication describes the state of this product at the time of its publication and may not reflect the product at all times in the future.





victron energie

USER MANUAL

Phoenix Combi 12/1000/50

Phoenix Combi 12/1600/75

Phoenix Combi 24/1200/30

Phoenix Combi 24/2000/50

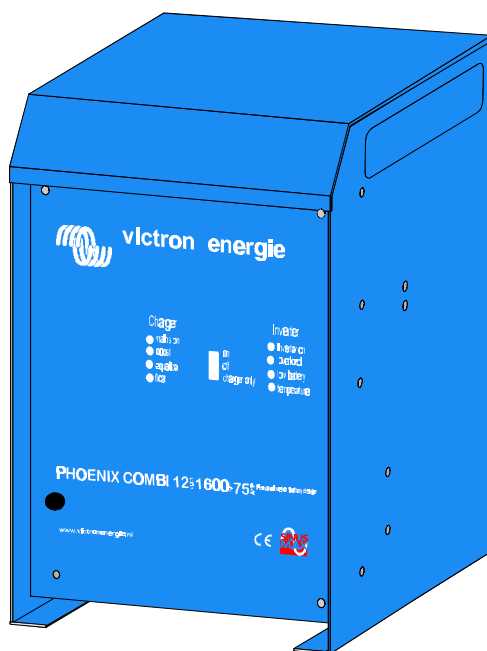



INTRODUCTION

Victron Energie has acquired international fame in the field of developing and producing electrical power supply systems. Thanks to the constant efforts of the development department in particular, Victron Energie obtain this world fame. This department is involved in research into and execution of facilities for implementing new technologies that can make significant technical and economic contributions to Victron Energie products.

This proven philosophy has resulted in the development of a complete series of power supply equipment incorporating the latest technical developments. Victron Energie equipment meets the most stringent standards and regulations. The range of high quality, dependable Inverters and Battery Chargers produced by Victron Energie can be used to generate 230Vac power in places where no permanent connection to mains electricity is available.

By using Victron Energie's products, an automatic 'stand-alone' power system can be created. Choosing the 'Phoenix Combi' in addition to powerful batteries for this type of system is often an ideal solution. The Phoenix Combi consists of a fully automatic battery charger, a sine-wave inverter and an automatic switchover device.

Victron Energie equipment is suitable for all types of electrical equipment for domestic, industrial and specialist use, including instruments susceptible to interference. Victron Energie systems are high quality energy sources that guarantee fault-free operation.

Phoenix Combi

This manual describes the installation, operation and the practical use of the Phoenix Combi. This manual also provides information about protection devices and the technical specifications of the Phoenix Combi.

CONTENTS

1.	DESCRIPTION	8
1.1	General.....	8
1.2	Phoenix Combi	8
1.3	The battery charger section.....	9
1.3.1	Temperature sensor.....	11
1.3.2	Voltage sense	11
1.4	The inverter section	11
1.5	Automatic switchover.....	12
1.6	Serial interface.....	12
2.	PROTECTION DEVICES.....	13
2.1	Start up power.....	13
2.2	Temperature protection.....	13
2.3	Low battery voltage protection	13
2.4	High battery voltage protection.....	13
2.6	Ripple voltage protection	14
2.7	Current protection	14
2.8	Start-up battery protection.....	15
2.9	Voltage sense protection.....	15
3.	INSTALLATION AND CONNECTION.....	16
3.1	Location.....	16
3.2	Requirements for installation.....	16
3.2.1	Requisites	16
3.2.2	Battery cables	17
3.3	Connection of wiring	17
3.4	Connection of battery cables.....	18
3.5	Connection of the start-up battery	19
3.6	Connection of 230 Vac cables.....	19
3.7	Connection of remote switch	20
3.8	Connection of remote sensing.....	20
3.8.1	Connection of voltage sense	20
3.8.2	Connection of temperature sensor.....	20
3.8.3	Connection of serial interface.....	21
3.9	Connection in parallel	22
4.	Operation.....	23
4.1	The battery charger section.....	24



4.1.1	The battery.....	24
4.1.2	Adjustment of output voltage battery charger	24
4.1.3	Adjustment of the equalize time	25
4.1.4	Permanent boost charging	26
4.1.5	Intelligent start-up	26
4.1.6	Turn off the charger.	26
4.1.7	Determining the input current.	27
4.2	The inverter section	28
4.2.1	Overload indicator.....	28
4.2.2	Low battery voltage indicator.....	28
4.2.3	High temperature indicator	28
4.2.4	Adjustment.....	29
4.2.5	60 Hz setting.....	29
4.2.6	Efficiency management.....	29
4.2.7	Calculation of battery capacity	29
4.3	The automatic switchover	31
4.3.1	Limiting input current.....	31
4.4	List of settings.....	32
4.5	Maintenance	32
5.	Trouble-shooting table.....	33
5.1	Problem solving	33
6.	Technical specifications	36
6.1	Inverter input.....	36
6.2	Inverter output	37
6.3	Charger input	39
6.4	Charger output.....	39
6.5	Automatic switchover	41
6.6	General.....	41
6.7	Mechanical	42
7.	DRAWINGS.....	43
7.1	Dimensions	44
7.2	Connection diagram.....	45
7.3	Parallel connection diagram.....	46



1. DESCRIPTION

1.1 General

All Phoenix Combi's are extensively tested before leaving the factory. This guarantees correct operation. For the purposes of transport the equipment packed in shock-absorbing polystyrene foam and a rigid cardboard carton.

The Phoenix Combi has a rigid aluminium housing, suitable for floor and wall mounting. The AC and DC terminals along with the connections for remote control (optional) are accessible via the front of the housing. The front panel can be removed using a screwdriver.

1.2 Phoenix Combi

The model name of the Phoenix Combi is composed of the following elements:

Example: Phoenix Combi 12/1600/75

"12" = 12 Volt battery voltage.

"1600" = 1600 Watt continuous output power.

"75" = 75 Ampere continuous charging current.

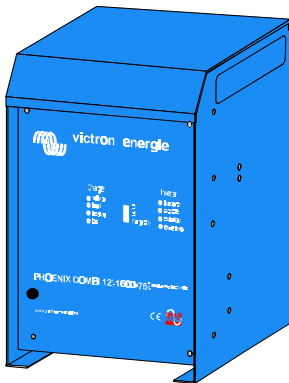

The Phoenix Combi is suitable for use with either 12Vdc or 24Vdc systems depending on the model chosen.

The inverter supplies a pure sinusoidal voltage of 230 Vac, 50/60 Hz (crystal-controlled). The inverter and the battery charger supply the specified output power or charging current.

The Phoenix Combi uses high frequency switching technology in combination with a low frequency transformer, which results in a high output and a high start-up power for the inverter. The 'no-load' power consumption is described in section 6.

Ampere =
unit of current

Volt =
unit of voltage

Watt =
unit of power

Hertz =
unit of frequency

Volt rms =
Root mean square value of the voltage

The output power of the Phoenix Combi inverter is:

Model	Continuous power	Start up power	P30 power
Phoenix-Combi 12/1000/50	1000 W	2300 W	1400 W
Phoenix-Combi 12/1600/75	1600 W	4500 W	2500 W
Phoenix-Combi 24/1200/30	1200 W	3000 W	1600 W
Phoenix-Combi 24/2000/50	2000 W	6000 W	3000 W

In addition the battery charger supplies:

Model	Continuous max. output current	Continuous max. output voltage ¹
Phoenix-Combi 12/1000/50	50 A	15 V
Phoenix-Combi 12/1600/75	75 A	15 V
Phoenix-Combi 24/1200/30	30 A	30 V
Phoenix-Combi 24/2000/50	50 A	30 V

1.3 The battery charger section

The Phoenix Combi has a fully automatic battery charger 12 Vdc or for 24 Vdc batteries and is supplied by a mains voltage of 230 Vac, 50 Hz. The battery charger charges the battery in accordance with the IUoUo characteristic, this is a 3-stage charging characteristic, see figure 1. During charging the battery voltage and current are continuously measured, the charging voltage is adjusted in the light of these measured values. You can find the value and adjustments of the equalize and float voltages in section 6.

Assuming the battery is exhausted, it is first charged in the boost phase. The battery is charged until the battery voltage is equal to the equalize voltage. The battery is then charged to around 80% of its capacity and the charger automatically switches to the equalize phase.

¹ If the output voltage is set to this, standard settings are indicated in section 6.

If the voltage of the connected battery is lower than 8 Vdc respectively 16 Vdc, the mains voltage must be at least 200 Vac to be able to start up the charger.

In the equalize phase the charging voltage remains constant, but the charging current gradually falls. The duration of this phase can be set to 0, 2, 4 or 8 hours. The standard setting of the equalize phase is 4 hours. As soon as this time has elapsed the charger automatically switches over to the float phase.

In the float phase the charging voltage is equal to the float voltage and the charging current is minimal. This phase lasts 20 hours.

After the float phase the charger switches back to the equalize phase for 30 minutes. During this time the battery is briefly charged to compensate for the internal losses of the battery.

The charger can be left connected to the battery for a long time, without gas formation occurring in the battery due to overcharging. So the battery does not have to be disconnected from the charger during for example the winter storage period of a ship. The charger keeps the battery in an optimum, which results in a longer life of the battery.

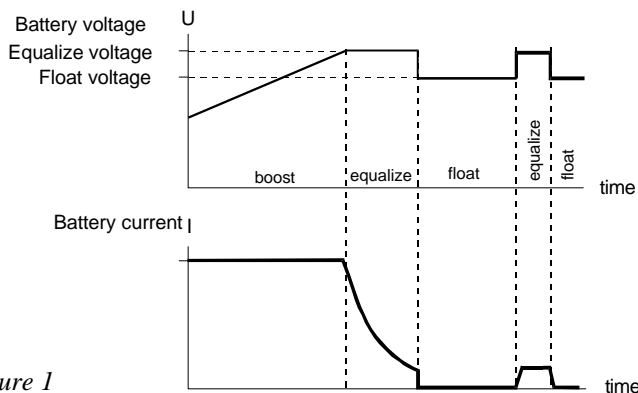

Figure 1

The Phoenix Combi charger automatically switches to the boost phase as soon as the battery voltage falls below the minimum value. Too low a battery voltage may be caused by a load connected to the battery.

The Phoenix Combi charger has a separate connection to charge an extra battery, for example a start-up battery (trickle charge).

1.3.1 Temperature sensor

With the Phoenix Combi a temperature sensor is standardly supplied. This sensor is provided with a 3 metre long cable and is intended for measuring the temperature of the battery. If connected the charging voltage is compensated for the battery temperature.

The adjustment of the battery voltage to the battery temperature is necessary to charge the battery in the best possible way and to ensure a long lifetime. If the battery temperature is above room temperature the charging voltage will fall. So with a low battery temperature the charging voltage will increase, after all a battery with a low temperature may be charged with a higher voltage. See figure 2.

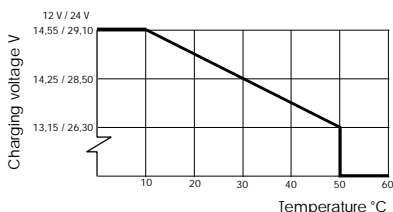

Figure 2

1.3.2 Voltage sense

When a high current runs through the cables between the charger and the battery there is voltage loss across the cables. The voltage, measured at the battery poles, will then be lower than the charging voltage of the charger. As a result it takes longer to charge the battery. For this reason the Phoenix Combi battery charger has a Voltage sense option. The Voltage sense accurately measures the battery voltage and increases the output voltage as soon as there is a voltage loss over the battery cables.

The charger cannot compensate for more than 2V (for 12V) and 4V (for 24V) of voltage loss. As soon as the voltage loss is more than 2V (for 12V), 4V (for 24V) the charging voltage will be adjusted back so that the voltage loss is a maximum of 2V (for 12V), 4V (for 24V). When this happens the charger must be switched off and the battery cables checked or replaced because they are too thin or because they are incorrectly connected.

1.4 The inverter section

The inverter section has been specially developed for mains powered equipment that depends on pure sinusoidal input voltage for effective and efficient operation.

1.5 Automatic switchover

The automatic switchover operates fully automatically. When an external 230Vac mains supply is available at the input of the Phoenix Combi, this power is used for the mains output and for operating the battery charger - see section 6 for technical specifications.

As soon as the 230 Vac input voltage is too low the inverter is immediately switched on to continue to supply the users connected.

This switchover takes place so quickly that the users do not notice it.

The Phoenix Combi continuously checks whether there is mains voltage. If for at least 3 seconds:

- the voltage is sufficiently high.
- the frequency is correct.
- the frequency variation is not too high (tracking rate).

the mains voltage is switched on and the inverter shuts down. Before switching over the inverter will first synchronise itself with the mains voltage, then the mains voltage is switched in parallel with the inverter. After this the inverter is switched off, therefore there is no noticeable interruption of the output.

1.6 Serial interface

The Phoenix Combi can be connected to a serial databus. In combination with an RS485 interface and the Victron Information Protocol, V.I.P., communication can be carried out with one or more remote panels. It is also possible to connect several items of Victron Energie equipment to this databus. The total of the number of units and panels that can be connected to this databus is a maximum of 32 items. Each unit is given a unique identification code during production so that the remote panel can read out or adjust each unit separately.

By means of this databus and a remote panel it is then possible to change the settings of the Phoenix Combi remotely. It is also possible to obtain information remotely on the output voltage, current and frequency of both the battery charger and the inverter.

2. PROTECTION DEVICES

A number of protection devices are incorporated in the Phoenix Combi that protect the unit and the equipment connected from internal electronic damage.

2.1 Start up power

The Phoenix Combi inverter can deliver a high power for short periods (see Table in paragraph 1.2). This power is electronically limited. If the inverter is overloaded the 'overload' LED will flash. If the overload is too high the equipment will switch off and the 'overload' LED will stay on continuously. After approx. 30 seconds the inverter starts up again automatically.

2.2 Temperature protection

The temperature of the electronics is continuously measured. Thanks to this temperature monitoring the equipment is switched off if the temperature threatens to rise too high due to shorting, overload or an extremely high ambient temperature. The 'temperautre' LED will flash to indicate that the critical temperature has almost been reached. If the internal temperature is too high, the 'temperautre' LED will remain on continuously and the equipment switches off. As soon as the temperature has fallen sufficiently, the equipment starts up again automatically.

2.3 Low battery voltage protection

During inverter operation, as soon as the battery voltage reaches a value that is too low the inverter is switched off. When the input voltage has risen again the inverter comes back into operation after approx. 30 seconds.

2.4 High battery voltage protection

During inverter operation as soon as the battery voltage has reached a value that is too high the inverter is switched off. When the input voltage has fallen again the inverter comes back into operation after approx. 30 seconds.

2.5 Reverse polarity indicator

The Phoenix Combi has a reverse polarity indicator. By only fitting the fuse in a later stage in the unit one can see whether the battery voltage offered is of the right polarity. If the polarity is correct the fuse can be fitted and the unit is ready for operation.

2.6 Ripple voltage protection

The Phoenix Combi is protected against a ripple voltage. Too high a ripple voltage can be prevented both in charger and in inverter operation. Too high a ripple voltage can be caused by a low capacity battery or by the battery cables being too long and / or too thin. Either dynamos can be the perpetrator of a too high ripple voltage.

If the value of the ripple voltage on the input is high the inverter will give an alarm; the 'low battery' LED and the 'overload' LED will flash, see section 6 for the maximum value of the ripple voltage. If the input voltage ripple is too high or the preceding alarm situation remains for a period of 21 minutes, the inverter will switch off and the following alarm indication can be seen; the 'low battery' LED and the 'overload' LED will remain on continuously.

The Phoenix Combi inverter must be reset by switching it off and on again.

2.7 Current protection

The battery charger part is protected against short circuiting by means of a fuse on the input side. If the output of the battery charger has been shorted fuse F2 might be blown. In that case first check your installation before replacing the fuse.

The output of the inverter is also protected against shorting. The maximum output current is electronically limited to a maximum current, see Table at section 6.2.

The mains voltage (when output is fed by incoming supply) is also limited by an automatic fuse of 16 A. If this value is exceeded the fuse will break the contact. After the fault has been removed from the installation the automatic fuse can be switched on again by pressing the fuse button, see figure 3.



Figure 3

2.8 Start-up battery protection

The output current of the start-up battery is electronically limited to 4 A.

2.9 Voltage sense protection

If the voltage drop over the battery cables is more than 2V (for 12V models) or 4V (for 24V models) the battery charger will automatically reduce the charging voltage. In that case the “low battery” LED will flash.

If the voltage sense wires are not properly connected the charging section will continue to work normally as if the voltage sense wires were not connected. In this case the “low battery” LED will also flash.

3. INSTALLATION AND CONNECTION

3.1 Location

The Phoenix Combi must be installed in a dry, well-ventilated room.

TAKE CARE!

Too high an ambient temperature has the following consequences: lower output, shorter life or complete shut-down of the Phoenix Combi. See for more information section 6 (“Technical specifications”).

The housing of the Phoenix Combi is suitable for floor and wall mounting. For mounting purposes there are holes on the bottom and back of the housing. For the relevant dimensions please refer to section 7 (“Drawings”).

The Phoenix Combi has a built-in fan. There are no restrictions with regard to the position in which the combi is mounted. Nonetheless it is recommended that the unit be mounted vertically. The cooling is in fact best in this position. Take care that the inside of the combi is also easily accessible after installation.

The distance between the Phoenix Combi and the battery must be kept as short as possible to minimise the voltage loss in the cables.

3.2 Requirements for installation

Use the tools mentioned in paragraph 3.2.1 for the installation of the Phoenix Combi.

3.2.1 Requisites

- Two battery cables (maximum length 6 metres) including battery terminals, see for the diameter the Table in 3.2.2.
- A box spanner (13 mm or M8) for tightening the connecting bolts.
- A box spanner (8 mm or M5) for the connection of the fuse.
- A screwdriver (no. 2) for the connection of the 230 Vac cables.

3.2.2 Battery cables

The Table below shows recommended battery cables. The cross-section of the battery cables is such that these are suitable for continuous load and peak load.

Model	Length 0 – 1.5 metres	Length 1.5 – 6 metres
Phoenix-Combi 12/1000/50	25 mm ²	35 mm ²
Phoenix-Combi 12/1600/75	50 mm ²	70 mm ²
Phoenix-Combi 24/1200/30	16 mm ²	25 mm ²
Phoenix-Combi 24/2000/50	35 mm ²	50 mm ²

Tighten the nuts firmly to prevent contact resistances.

3.3 Connection of wiring

The connection of the wiring is an important step in the installation.

The connection points are located on the printed circuit board in the inverter (see figure 4). The cable terminals are given a code ("+" or "-"). Also take good care with the input of the charger and the output of the inverter.

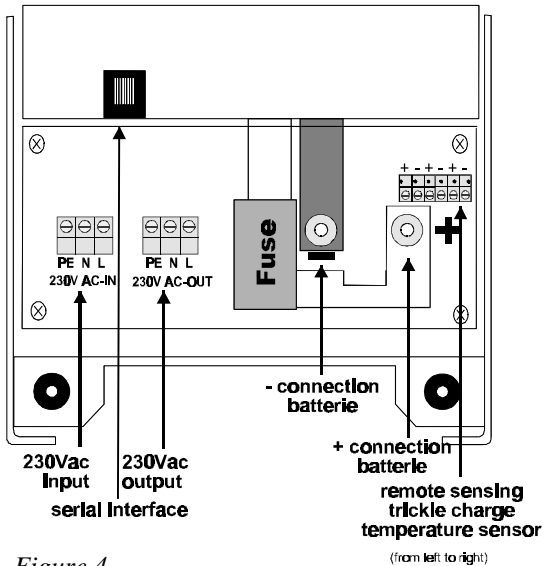

Figure 4

Ground connection

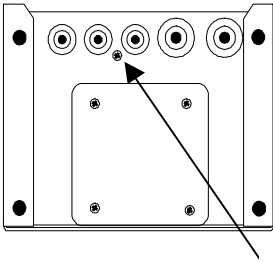

Figure 5

Ground screw

For the ground connection the ground wire (ground conductor) of the mains current must be connected to the ground of the AC output terminal block “PE” (figure 4). The circuit thus created is however only active if the housing is also connected to the ground. The housing is fitted with an M4 ground screw for this purpose (figure 5).

To close the circuit, this housing ground must be connected to the ground. On ships the housing can be "grounded" by connecting it to the ship's hull or the ground plate. In cars grounding can be made with the chassis.

3.4 Connection of battery cables

In order to fully utilise the capacity of the Phoenix Combi (in particular for peak loads and when charging the batteries), only battery cables of the right thickness must be used. See paragraph 3.2.2.

Procedure

Proceed as follows for connecting the battery cables:

- Unscrew the four screws on the front of the housing.
- Connect the battery cables to: the ‘+’ (red) on the right and the ‘-’ (black) on the left.
- If the battery cables of the combi are changed over (+ on – and – on +), the red LED will come on.
- If the red LED comes on, disconnect the cables and connect them correctly.
- Fit the fuse.
- Check whether all the connections are properly tightened.
- If you disconnect the battery again you must first disconnect the other equipment connected to the battery.

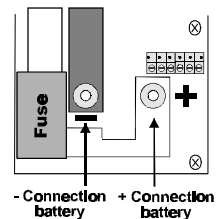
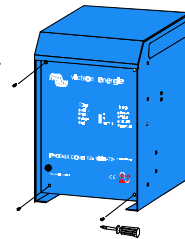

3.5 Connection of the start-up battery

The start-up battery must be connected with a cable with a core of at least 1.5 mm².

- Connect the positive (+) battery pole to the left side of the start-up battery connection (trickle charge), see figures 4 and 7a.
- Connect the negative (-) battery pole to the right side of the start-up battery connection (trickle charge), see figures 4 and 7a.

3.6 Connection of 230 Vac cables

The terminal block is located on the printed circuit board (see figure 4). The 230 Vac from the harbour or mains must be connected to the Combi using a three-core cable. Use a three-core cable with a flexible core and a cross-section of 2.5 to 4 mm².

Procedure

Proceed as follows for connecting the 230 Vac cables:

- The 230 Vac user equipment can be connected directly to the terminal block with the text “230 Vac –out” on the printed circuit board using a three-core cable.
- The 230 Vac mains voltage can be connected to the terminal block with the text “230 Vac – in”. The connection points are clearly coded. From left to right: "PE" (ground), "N" (neutral conductor) and "L" (phase).

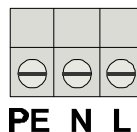

3.7 Connection of remote switch

The Phoenix Combi can be switched on and off using the remote control. If with the remote control contact is made between “ground” and “on” then the Phoenix Combi is in the “on” position, if contact is made between “ground” and “charger only” then the Phoenix Combi is in the “charger only” position. (see figure 6a and 6b).

3.8 Connection of remote sensing

Two remote sensors can be connected to the Phoenix Combi. These are the voltage sense and the temperature sensor.

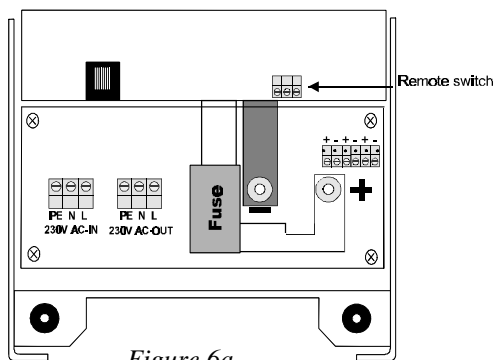

Figure 6a

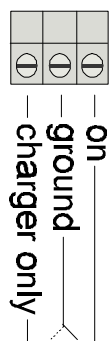

Figure 6b

3.8.1 Connection of voltage sense

- Switch off the mains voltage.
- Connect a red 0.75mm² wire between the positive battery pole and the “+ V-sense” connector, see figure 4 and 7a.
- Connect a black 0.75mm² wire between the negative battery pole and the “- V-sense” connector, see figure 4 and 7a.
- Connect the mains voltage.

3.8.2 Connection of temperature sensor

The temperature sensor supplied can be connected to the charger with a 3 metre long cable with stripped and tin-plated cable ends, see figure 7b. The sensor must be mounted on the battery. The sensor regulates the charging voltage depending on the battery temperature. This cable may have a maximum length of 12 m.

Connection of the temperature sensor:

- Switch off the mains voltage.
- Connect the (-) black wire of the temperature sensor to the “- T-sense” connector, see figure 4 and 7.
- Connect the (+) red wire of the temperature sensor to the “+ T-sense” connector, see figure 4 and 7.
- Switch the mains voltage back on.

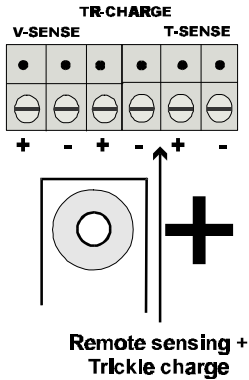

Figure 7a

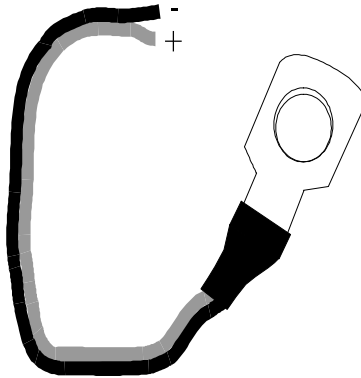

Figure 7b

3.8.3 Connection of serial interface

The serial databus can be connected using a standard 8-pole datacable. For this a standard 8-pole dataconnector can be used which can be connected to the connector of the Phoenix Combi, see figure 4. This cable may have a maximum length of 100 m.

If several units are connected to the databus connected this can be done using a simple splitter box. Equipment connected to the databus and not switched on has no effect on the operation of the databus.

Pinning of the 8-pole data cable:

Pin no.	Description
1 NC	Not connected
2 +Vdc_out	Positive supply voltage for a remote panel
3 Ground	Ground
4 Data_ser_A	Serial dataline A
5 Data_ser_B	Serial dataline B
6 R_Standby	Remote standby
7 NC	Not connected
8 NC	Not connected

- After installation replace the front of the housing and tighten the four screws.

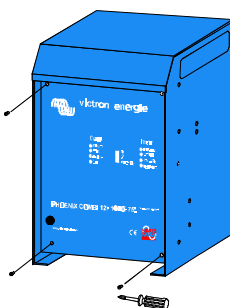

3.9 Connection in parallel

This combi can be connected in parallel to several units of the same model, see figure at section 7.3. This makes it possible and simple to increase the load capacity. To accomplish this, a connection is made between the devices using a special cable provided by Victron Energie with a connecting diagram (ask your dealer).

For parallel connections the following conditions must be met:

- Do not connect more than five devices in parallel.
- Connect only devices of the same type in parallel.
- Make sure you have sufficient battery capacity.
- The prescribed cable thicknesses should be multiplied by the number of devices to be connected in parallel.
- Place the devices close together, but make sure there is enough space between them for ventilation.
- Provision must be made to connect the 1,5 metre-long parallel cable.

4. Operation

The switch and the LEDs are located on the front of the Phoenix Combi (see figure 8).

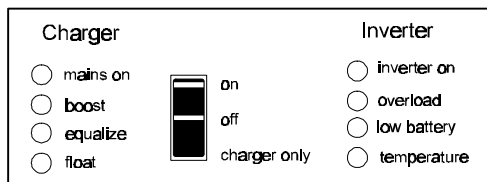

Figure 8

LEDs:

- mains on : lights up when the mains voltage is present and the switch is set to “on”. Flashing if wall current is limited.
- boost : lights up when the battery charger is charging in Boost mode.
- equalize : lights up when the battery charger is charging in Equalize mode.
- float : lights up when the battery charger is charging in Float mode.
- inverter on : lights up when no mains voltage is present and the switch is set to “on”.
- overload : lights up if too high a load is connected to the inverter.
- low battery : lights up if the battery voltage is too low.
- temperature : lights up if the inverter or charger is switched off because of too high an ambient temperature.

on/off/charger only switch

Using the “on/off/charger only” switch the Phoenix Combi can be switched to on, off or charger only respectively, (see figure 8).

When the switch is switched to “on” and mains voltage is present, the “mains on” LED will remain on continuously. In that case the mains voltage is switched to the inverter output and the battery charger comes on. Depending on the charging mode applicable at that time the “boost”, “equalize” or “float” LED will be on.

If no mains voltage is present then the inverter will be switched on, in that case the “inverter on” LED will come on. If the switch is set to “charger only” the battery charger of the Phoenix Combi will only switch on if mains voltage is present. In that case the mains voltage is switched to the inverter output.

4.1 The battery charger section

The Phoenix Combi battery charger is a fully automatic charger for 12V or 24V batteries, (depending on the model) and is supplied by a mains voltage of 230 Vac, 50 Hz. The battery charger charges the battery in accordance with the IUoUo characteristic; this is a 3-stage, fully automatic charging method. During charging the battery voltage and current are measured continuously, the charging voltage is adjusted in the light of these measured values.

4.1.1 The battery

Below is a Table showing the recommended battery capacity:

Model	Recommended capacity
Phoenix-Combi 12/1000/50	120 - 300 Ah
Phoenix-Combi 12/1600/75	300 – 600 Ah
Phoenix-Combi 24/1200/30	120 – 200 Ah
Phoenix-Combi 24/2000/50	200 - 400 Ah

The charging voltages of the Phoenix Combi charger are set in the factory. Most battery manufacturers recommend these charging voltages for the optimum charging of 12 V or 24 V lead-acid batteries.

It is possible to charge different types of batteries such as traction batteries. To be able to charge these batteries the charging voltage of the charger must be changed. Contact your Victron Energie dealer or your battery supplier for the recommended charging voltages.

4.1.2 Adjustment of output voltage battery charger

To be able to adjust the output voltage of the inverter, the housing of the Phoenix Combi must be opened. For this unfasten the four screws on the front.

Changing the float voltage:

- Remove all other loads that are connected to the output of the charger.
- Connect the mains voltage and set the switch of the Phoenix Combi to “Charger only”.
- Slide the DIP- switches DS6 and DS7 to the right. This has the effect of shortening the equalize time to 0 hours, and the charger then switches immediately to float switches.
- Measure the float voltage with a precision voltmeter.



- Adjust the float voltage to the required value with potentiometers R53, see figure 9. The float voltage can only be adjusted with a fully charged battery.
- Correct the equalize time by pushing back DIP switch DS7.

Changing the equalize voltage:

- The equalize voltage can only be adjusted with a full battery.
- Push DIP switch DS8 to the left. The charger now switches to permanent boost.
- Measure the equalize voltage with a precision voltmeter.
- Adjust the equalize voltage to the required value with potentiometer R54, see figure 9.
- Push DIP switch DS8 back to the right.



4.1.3 Adjustment of the equalize time

The time of the equalize phase can be changed to meet the battery specifications as far as possible. The time can be set at 0, 2, 4 or 8 hours. If 0 hours is selected this means that the charger jumps the equalize phase and so switches directly to the float phase. The standard setting of the equalize time is 4 hours.

The equalize time can be set by moving DIP switches DS6 and DS7 as shown in the example below.

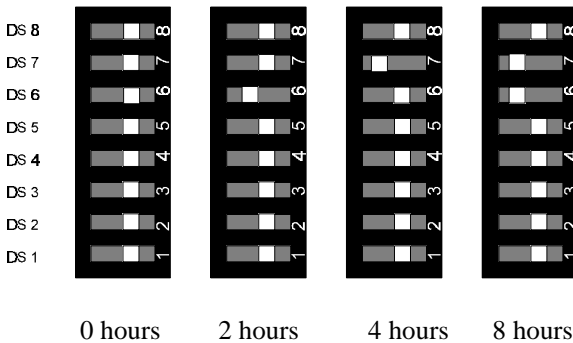

4.1.4 Permanent boost charging

When the battery is almost fully discharged, it is advisable to charge the battery for 10 hours on boost. Do not do this with gas-tight lead-acid batteries. Contact your Victron Energie dealer or your battery supplier for more information on the charging of batteries.

Setting the charger to permanent boost:

- Push DIP switch DS8 to the left. In this position the battery can only be charged on boost.

It is not advisable to charge the battery for longer than 10 hours on permanent boost; this can cause gas formation in the battery which can cause serious damage.

During permanent boost charging regularly check the water level in the battery and top this up if necessary.



4.1.5 Intelligent start-up

If a battery is connected, the battery charger will automatically sense the voltage of the battery and select which charging mode to start in. If the battery voltage is below the minimum value the battery charger will start in boost or equalize mode. If the battery voltage is above the minimum value V_{min} then the charger will start in float mode. In this way a full battery is not overcharged. The value of V_{min} is indicated in section 6.

If required, the charger can always start in boost mode, followed by equalize mode and float mode. For this the “battery recondition” option, DS4 is pushed to the left. Always starting in the boost mode will limit the life of the battery.



4.1.6 Turn off the charger.

The charger part can be turned off in two ways:

- Put DS2 and DS3 to the left. (The transfer switch will still be working).
- Or connect a Phoenix Inverter Remote Panel (PIV).



0A

4.1.7 Determining the input current.

If a Phoenix Combi Remote Panel (PCV) is connected, normally this will determine the input current, regardless of the dipswitch setting. This is not the case when the Phoenix Combi is at “ON” position and dipswitch setting at 0 A.

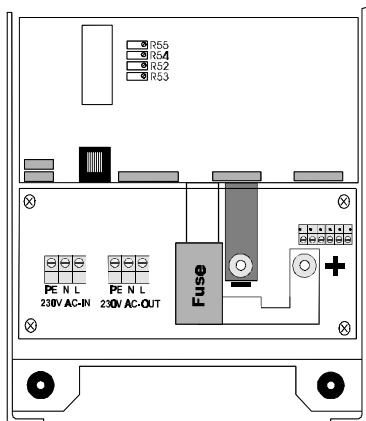

Figure 9

4.2 The inverter section

The inverter section has been specially developed for mains voltage equipment that depends on a pure sinusoidal input voltage for effective and efficient operation. Certain equipment does in fact only function without problems on a sinusoidal voltage. This applies to, amongst other things, computers, equipment for communications and precision measuring instruments.

4.2.1 Overload indicator

If the inverter becomes overloaded, the "overload" LED will flash. If the overload is too high the inverter will automatically switch off, then the 'overload' LED will remain on continuously. After approx. 30 seconds the inverter starts up again automatically.

4.2.2 Low battery voltage indicator

The "low battery" LED will flash if the battery voltage is lower than 10,9 Vdc (at 12V) and 21,8 Vdc (at 24V) and the LED lights up continuously when the input voltage of the inverter is too low. The inverter is immediately switched off automatically in such a case.

Too low an input voltage is caused by:

- An exhausted battery.
- A relatively low battery capacity compared with the high battery load as a result of which the terminal voltage falls considerably.
- Battery cables too thin and/or too long.
- Poor condition of the batteries.
- Bad connections at battery or inverter.

As soon as the input voltage has risen sufficiently the Phoenix Combi starts up again after approx. 30 seconds.

4.2.3 High temperature indicator

The Phoenix Combi has forced cooling using a fan. This fan runs at half speed from a load of approximately 0.4x the nominal load. The speed then increases linearly, as the load becomes greater.

In case of a high ambient temperature the "temperature" LED comes on and the fan runs at full speed. When such a situation occurs, the Phoenix Combi is automatically switched off. The Phoenix Combi starts up again as soon as the temperature has fallen sufficiently.

4.2.4 Adjustment

To be able to adjust the output voltage of the inverter, the housing of the Phoenix Combi must be opened. For this unfasten the four screws on the front.

The output voltage of the inverter is adjusted as standard to 230 Vac. Using potentiometers R52 (see figure 9) the output voltage can be changed by approx. +5% and -20%.

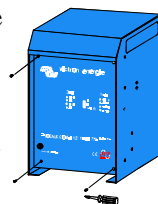

4.2.5 60 Hz setting

Some equipment only works correctly at 50 Hz or at 60 Hz. The inverter of the Phoenix Combi can generate a 230 Vac sinusoidal alternating voltage with a frequency of 50 Hz or 60 Hz. The frequency can be set at 60 Hz by moving DIP switch DS5 to the left, see the figure alongside. As standard the inverter is set at 50 Hz.



4.2.6 Efficiency management

In the design special attention has been paid to an extremely low own consumption with low or absent load. As a result an economy-position is superfluous and all small consumers such as clocks, electronic displays and connected equipment continue to operate normally in a stand-by position.

4.2.7 Calculation of battery capacity

The required minimum battery capacity can be calculated. As a starting point for the calculation the duration and the absorbed power of the equipment which must be supplied using a Phoenix Combi inverter must be known.

For the calculation first make a list in which the equipment that must be supplied using a Phoenix Combi inverter is summed up. Note for each separate unit the absorbed power and multiply that by the time (in hours) during which power is absorbed (Watt-hours). Count the internal loss of the Phoenix Combi inverter here.

The internal loss is calculated from two components. If the inverter is supplying power, the Phoenix Combi has an output of 85%. A further 15% must therefore be added to the calculated power. If no power is supplied one must take into account the no-load consumption of the Phoenix Combi (see section 6).

Then determine the number of ampere-hours (Ah) by dividing the absorbed power by the nominal battery voltage (12 Volt or 24 Volt). The result of this

calculation gives the current consumption in ampere-hours and hence the total consumption capacity of the battery in ampere-hours (Ah).

Multiply this value by a safety factor of 1.7. The result thus obtained indicates the required battery capacity.

Below is an example of this calculation, applied to the Phoenix Combi 12/1600/75.

Unit	Power	Duty cycle in hours	Consumption
CTV	200 W	4	800 Wh
Video recorder	50 W	4	200 Wh
Hi-fi installation	100 W	6	600 Wh
Lighting	300 W	3	900 Wh
Computer	100 W	3	300 Wh
Cooking ring	750 W	1	<u>750 Wh</u>

Total consumption **3550 Wh**

Internal loss (3550/85%) x 15% 626 Wh

Internal loss during 12 hours without power supply
(12 hours x 6.5 W) 78 Wh

Total power consumption **4254 Wh**

Total consumption capacity of the battery (4254 Wh/ 12 Volt):354,5 Ah

Daily consumption	Safety factor	Required Ah
354,5 Ah	x 1.7	= 602,7 Ah

Based on a required Ah value of 602,7, the battery capacity must be 600 Ah.

For sealed and gel batteries a different recommended safety margin may apply, sometimes to 1.3. As a result it is possible to use a battery with a smaller capacity. For this consult the specifications of the manufacturer.

4.3 The automatic switchover

When the mains voltage is connected to the Phoenix Combi, the green “mains on” LED comes on. The load of the inverter output is then switched directly to the mains voltage. As a result the inverter will not supply any further power, see for more information paragraph 1.5.

If the switch is on “charger only” when mains voltage is present the battery charger will come on. In that case the mains voltage is also switched to the inverter output.

4.3.1 Limiting input current

The maximum input current of the Phoenix Combi is 16A. It is however possible to limit the input current. This may for example be useful if your ship is connected to a shore supply fuse with a lower value. In this way you prevent the shore fuse tripping. As standard the Phoenix Combi is set at 16A.

The setting of the maximum input current can be made using DIP switches DS 2 and DS 3. The setting is carried out in accordance with the figure below:

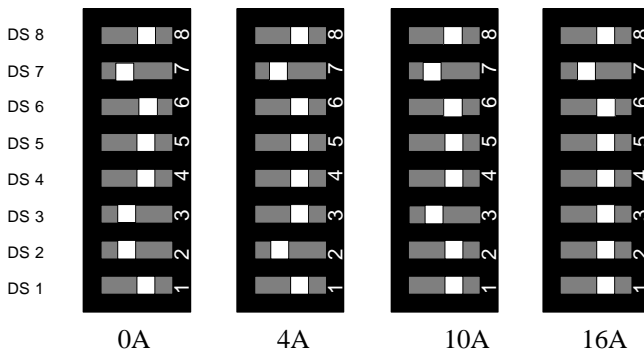

Besides the input current can be limited with the accompanying remote panel. During limiting the input current the “mains on” LED starts to flash, on the Phoenix Combi as well as on the remote panel, at the moment that the input current is equal to the load current. By slowly turning the potentiometer of the remote panel counterclockwise till the point where the LED starts to flash, the current of the accompanying scale can be read.

Take care! Setting a maximum input current lower than 16A has the result of limiting the maximum charging current.

4.4 List of settings

Function	DIP switch	
Permanent boost	DS8 left	
Equalize time	0 hours	DS6 right DS7 right
	2 hours	DS6 left DS7 right
	4 hours	DS6 right DS7 left
	8 hours	DS6 left DS7 left
60 Hz	DS5 left	
Battery recondition	DS4 left	
Limiting input current	0 A	DS2 left DS3 left
	4 A	DS2 left DS3 right
	10 A	DS2 right DS3 left
	16 A	DS2 right DS3 right



Standard setting

DIP switch DS1 is not used and may be positioned either on the left or right. All functions can be switched by moving the DIP switch to the “on”-position (to the left). Default adjusting is all DIP switches to the right, except DS7.

4.5 Maintenance

The Phoenix Combi requires no specific maintenance. It is sufficient for all the connections to be checked once per year. Prevent the Phoenix Combi getting damp and keep the unit as clean as possible.

5. Trouble-shooting table

Using the step-by-step plan below the commonest faults can quickly be traced. Before tests are carried out with the inverter and/or battery charger the other 12 Vdc or 24 Vdc and 230 Vac equipment must be disconnected from the batteries and the inverter.

5.1 Problem solving

If the fault cannot be solved, consult your Victron Energie dealer.

Problem	Cause	Solution
The inverter does not work when it is switched on.	The battery voltage is too high or too low.	Make sure the battery voltage is within the right value, see paragraph 7.
The “low battery” LED flashes.	The battery voltage is low.	Charge the battery or check the battery connections.
The “low battery” LED is on.	The inverter switches off because the battery voltage is too low.	Charge the battery or check the battery connections.
The “low battery” LED flashes.	There is a voltage loss in the battery cables of more than 2 Volts.	Switch the charger off. Replace the battery cables or connect them properly.
	Or the voltage sense wires are connected back to front.	Turn the charger off and connect the voltage sense wires correctly.
The “overload” LED flashes.	The load on the inverter is above the nominal load.	Disconnect part of the load.
The “overload” LED is on.	The inverter is switched off because the load is too high.	Disconnect part of the load.
The “temperature” LED flashes.	The ambient temperature is high, or the temperature of the internal components is high or the load is too high.	Place the inverter in a cool and well-ventilated environment or disconnect part of the load.

Problem	Cause	Solution
The “temperature” LED is on.	The inverter is switched off as a result of too high an ambient or component temperature or the load is too high.	Place the inverter in a cool and well-ventilated environment or disconnect part of the load.
The “low battery” and “overload” LED’s flash.	Low battery voltage and too high a load or the ripple voltage on the input reaches 10% of the DC value of the input voltage.	Charge the batteries, disconnect part of the load or fit batteries with a higher capacity. Fit shorter and/or thicker battery cables. Check dynamo.
The “low battery” and “overload” LED’s are on.	The inverter is switched off as a result of too high a ripple voltage on the input.	Fit a ripple-voltage suppresser and/or batteries with a higher capacity. Fit shorter and/or thicker battery cables and reset the inverter (switch off and back on again).
One alarm LED is on and the second flashes.	The inverter is switched off as a result of the alarm of the LED that is on. The flashing LED indicates that the inverter is about to be switched off by the alarm in question.	Check this table to take action depending on the alarm.
The charger does not work.	The value of the mains voltage must be between 185 Vac and 265 Vac.	Measure the mains voltage and make sure that this ends up at between the 185 Vac and 265 Vac.
	The input fuse is faulty.	Return the unit to your dealer.

Problem	Cause	Solution
The battery is not fully charged.	The duration of the equalize phase is too short.	Set the duration of the equalize phase to a longer time.
	A poor battery connection.	Check the battery connections.
	The boost voltage is set at the wrong value.	Adjust the boost voltage to the correct value.
	The float voltage is set at the wrong value.	Adjust the float voltage to the right value.
	The capacity of the battery is too big.	Connect a battery with a smaller capacity.
	The output fuses are faulty.	Replace the output fuses.
The battery is over charged.	The continuous boost option is switched on.	Switch the continuous boost option off.
	The boost voltage is set at the wrong value.	Adjust the boost voltage to the right value.
	The float voltage is set at the wrong value.	Adjust the float voltage to the right value.
	A poor battery.	Check the battery.
	Too small a battery.	Reduce the charging current.
	The battery is too hot.	Connect a temperature sensor.

6. Technical specifications

6.1 Inverter input

Input voltage nominal

Phoenix Combi 12/1000/50	12 Vdc
Phoenix Combi 12/1600/75	12 Vdc
Phoenix Combi 24/1200/30	24 Vdc
Phoenix Combi 24/2000/50	24 Vdc

Input voltage range

Phoenix Combi 12/1000/50	9,5 – 16,1 Vdc
Phoenix Combi 12/1600/75	9,5 – 16,1 Vdc
Phoenix Combi 24/1200/30	19,0 – 32,2 Vdc
Phoenix Combi 24/2000/50	19,0 – 32,2 Vdc

Switch-on voltage (low)

Phoenix Combi 12/1000/50	10,9 Vdc
Phoenix Combi 12/1600/75	10,9 Vdc
Phoenix Combi 24/1200/30	21,8 Vdc
Phoenix Combi 24/2000/50	21,8 Vdc

Switch-off voltage (low)

Phoenix Combi 12/1000/50	9,5 Vdc
Phoenix Combi 12/1600/75	9,5 Vdc
Phoenix Combi 24/1200/30	19,0 Vdc
Phoenix Combi 24/2000/50	19,0 Vdc

Switch-off voltage (high)

Phoenix Combi 12/1000/50	16,1 Vdc
Phoenix Combi 12/1600/75	16,1 Vdc
Phoenix Combi 24/1200/30	32,2 Vdc
Phoenix Combi 24/2000/50	32,2 Vdc

Voltage ripple

max. 1,50 Vrms AC on the nominal DC input voltage for 12 V.
max. 3,0 Vrms AC on the nominal DC input voltage for 24 V.

Input current nominal	
Phoenix Combi 12/1000/50	100 A at 12 V/1000 W
Phoenix Combi 12/1600/75	160 A at 12 V/1600 W
Phoenix Combi 24/1200/30	60 A at 24 V/1200 W
Phoenix Combi 24/2000/50	100 A at 24 V/2000 W

Input current maximum:	
Phoenix Combi 12/1000/50	200 A
Phoenix Combi 12/1600/75	400 A
Phoenix Combi 24/1200/30	150 A
Phoenix Combi 24/2000/50	300 A

Power consumption no-load:	
Phoenix Combi 12/1000/50	6 W
Phoenix Combi 12/1600/75	6 W
Phoenix Combi 24/1200/30	8 W
Phoenix Combi 24/2000/50	6 W

6.2 Inverter output

Output voltage	230 Vac +/- 1 %
Output voltage range	185 Vac – 245 Vac
Frequency	50 / 60 Hz +/- 0.2 % (crystal-controlled)
Waveform output voltage	pure sinusoidal
Total harmonic distortion	maximum 5 %
Power factor (cos phi)	0.2 capacitive to 0.4 inductive
Nominal power	
Phoenix Combi 12/1000/50	1000 W (cos phi = 1.0; 0°C - +40°C)
Phoenix Combi 12/1600/75	1600 W (cos phi = 1.0; 0°C - +40°C)
Phoenix Combi 24/1200/30	1200 W (cos phi = 1.0; 0°C - +40°C)
Phoenix Combi 24/2000/50	2000 W (cos phi = 1.0; 0°C - +40°C)

P30 power	
Phoenix Combi 12/1000/50	1500 W
Phoenix Combi 12/1600/75	2500 W
Phoenix Combi 24/1200/30	1700 W
Phoenix Combi 24/2000/50	3000 W

Peak power	
Phoenix Combi 12/1000/50	2250 W
Phoenix Combi 12/1600/75	4500 W
Phoenix Combi 24/1200/30	3000 W
Phoenix Combi 24/2000/50	6000 W

Switch-on behaviour The inverter can be switched on at any load.

Efficiency	P_{nom}	$\frac{1}{2}P_{nom}$
Phoenix Combi 12/1000/50	84 %	86 %
Phoenix Combi 12/1600/75	85 %	89 %
Phoenix Combi 24/1200/30	86 %	87 %
Phoenix Combi 24/2000/50	87 %	89 %

Dynamic stability maximum 10 % short-term deviations when switching on and off at 50 % of the nominal load

Restore time 3 periods

Overload protection The Phoenix Combi inverter is protected against overload.

Short-circuit protection The output is short-circuit protected. The short-circuit current is approx.:

Phoenix Combi 12/1000/50	10 Arms
Phoenix Combi 12/1600/75	20 Arms
Phoenix Combi 24/1200/30	13,5 Arms
Phoenix Combi 24/2000/50	27 Arms

Protection against mains on inverter output The output is protected against connecting a not- synchronized main voltage.

6.3 Charger input

Input voltage range	187 – 265 Vac, full output power available
Frequency range	45 – 55 or 55 – 65 Hz, full output power available
Maximum input current	At 230Vac input voltage:
Phoenix Combi 12/1000/50	4,0 A at 15 V / 50 A
Phoenix Combi 12/1600/75	6,0 A at 15 V / 75 A
Phoenix Combi 24/1200/30	4,7 A at 30 V / 30 A
Phoenix Combi 24/2000/50	8,1 A at 30 V / 50 A
Input fuse F2	
Phoenix Combi 12/1000/50	250 Vac / 10 A fast 6.3x32 mm
Phoenix Combi 12/1600/75	250 Vac / 15A fast 6.3x32 mm
Phoenix Combi 24/1200/30	250 Vac / 10 A fast 6.3x32 mm
Phoenix Combi 24/2000/50	250 Vac / 20 A fast 6.3x32 mm
Efficiency	
Phoenix Combi 12/1000/50	81 % at 230 Vac and 15 Vdc 50 A
Phoenix Combi 12/1600/75	82 % at 230 Vac and 15 Vdc 75 A
Phoenix Combi 24/1200/30	83 % at 230 Vac and 30 Vdc 30 A
Phoenix Combi 24/2000/50	84 % at 230 Vac and 30 Vdc 50 A
Cos phi / power factor	1.0

6.4 Charger output

Equalize charging voltage	
Phoenix Combi 12/1000/50	14.25 Vdc
Phoenix Combi 12/1600/75	14.25 Vdc
Phoenix Combi 24/1200/30	28.50 Vdc
Phoenix Combi 24/2000/50	28.50 Vdc
Float charging voltage	
Phoenix Combi 12/1000/50	13.25 Vdc
Phoenix Combi 12/1600/75	13.25 Vdc
Phoenix Combi 24/1200/30	26.50 Vdc
Phoenix Combi 24/2000/50	26.50 Vdc

Output voltage range

Phoenix Combi 12/1000/50	12-15	Vdc
Phoenix Combi 12/1600/75	12-15	Vdc
Phoenix Combi 24/1200/30	24-30	Vdc
Phoenix Combi 24/2000/50	24-30	Vdc

Minimum voltage V_{min} for start-up in float mode

Phoenix Combi 12/1000/50	$V_{float} - 0,75$	Vdc
Phoenix Combi 12/1600/75	$V_{float} - 0,75$	Vdc
Phoenix Combi 24/1200/30	$V_{float} - 1,5$	Vdc
Phoenix Combi 24/2000/50	$V_{float} - 1,5$	Vdc

Charging characteristic

I_{Uo}U_o

Current/voltage stability $\pm 1 \%$

Output current range

Phoenix Combi 12/1000/50	0-50	A
Phoenix Combi 12/1600/75	0-75	A
Phoenix Combi 24/1200/30	0-30	A
Phoenix Combi 24/2000/50	0-50	A
Maximum start-up battery-current	4	A

Battery leakage current, when the battery charger is switched off. ≤ 1 mA

6.5 Automatic switchover

Maximum switchover power	: 3680 W
Maximum change up power	: 3680 W (limited by 16A Thermal Circuit Breaker)
Switchover time from inverter to mains voltage	: none ²
Switchover time from mains voltage to inverter	: 20 ms
Switchover voltage mains voltage to inverter	: 170 Vac
Switchover voltage inverter to mains voltage	: 187 Vac
Frequency range	: 45 Hz – 65 Hz

6.6 General

Ventilation	Forced convection (internal)
Protection against too high ambient temperatures, overload and shorting	The temperature of critical components is measured with sensors (PTC 's). The combi switches off as soon as the maximum temperature of a component is exceeded. When the temperature has fallen, the combi automatically switches on again.
Relative humidity	0-95%
EMC:	Electromagnetic compatibility in accordance with EMC directive 89/336 EEC:
Emission	EN 55014 (1993) EN61000-3-2 EN61000-3-3
Immunity	EN 55104 (1995)
Safety	EN 60950-4 (1991) EN60335-2-29

² Because inverter and mains voltage operate in parallel for a short time there is no switchover time.

6.7 Mechanical

Housing	Aluminium, protection class IP21
Colour	Blue (RAL 5012)
Dimensions (h x b x d)	348 x 250 x 205
Weight	
Phoenix Combi 12/1000/50	12 kg
Phoenix Combi 12/1600/75	18 kg
Phoenix Combi 24/1200/30	12 kg
Phoenix Combi 24/2000/50	18 kg
Connection 230 Vac	Connections to printed circuit board (2 x connector suitable for 4 mm ² wires).
Connection 12 and 24 Vdc	Connections to printed circuit board (M8 bolts).
External connections:	
Sensing, remote switch and Start-battery	Connections to printed circuit board (connector suitable for 1.5 mm ² wires).
Serial interface	8-pole UTP connector

7. DRAWINGS

Phoenix Combi dimensions	44
Phoenix Combi connection diagram	45
Phoenix Combi parallel connection diagram	46



7.1 Dimensions

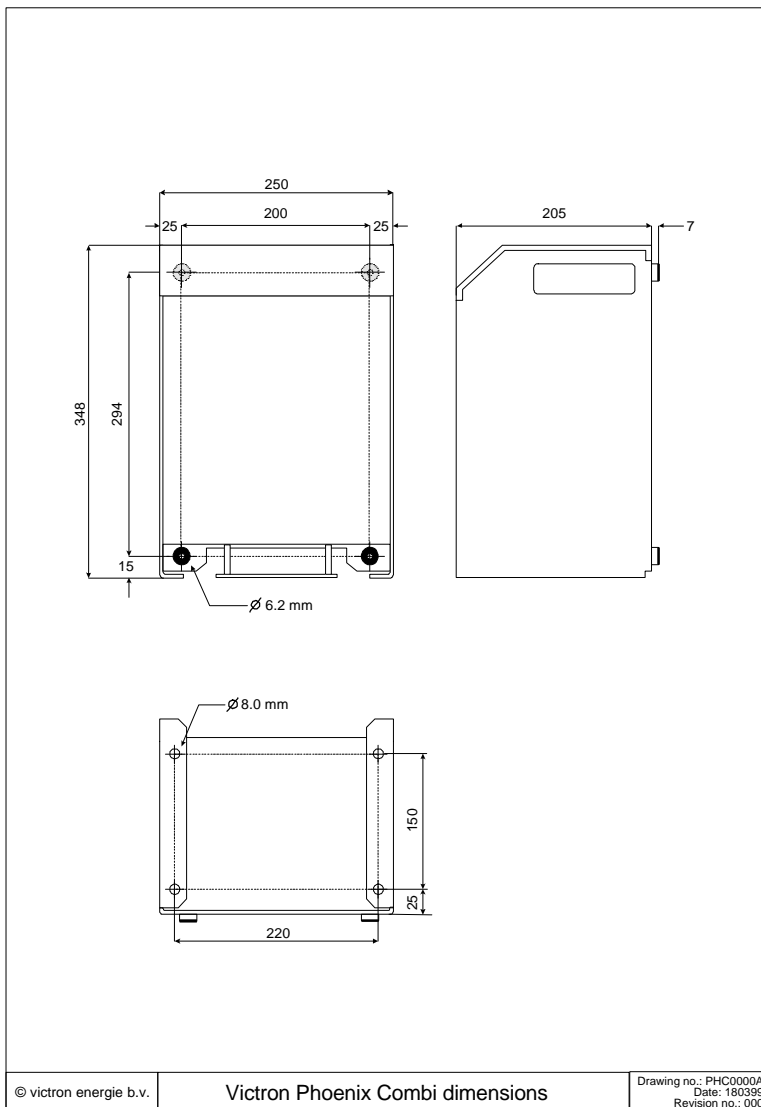

7.2 Connection diagram

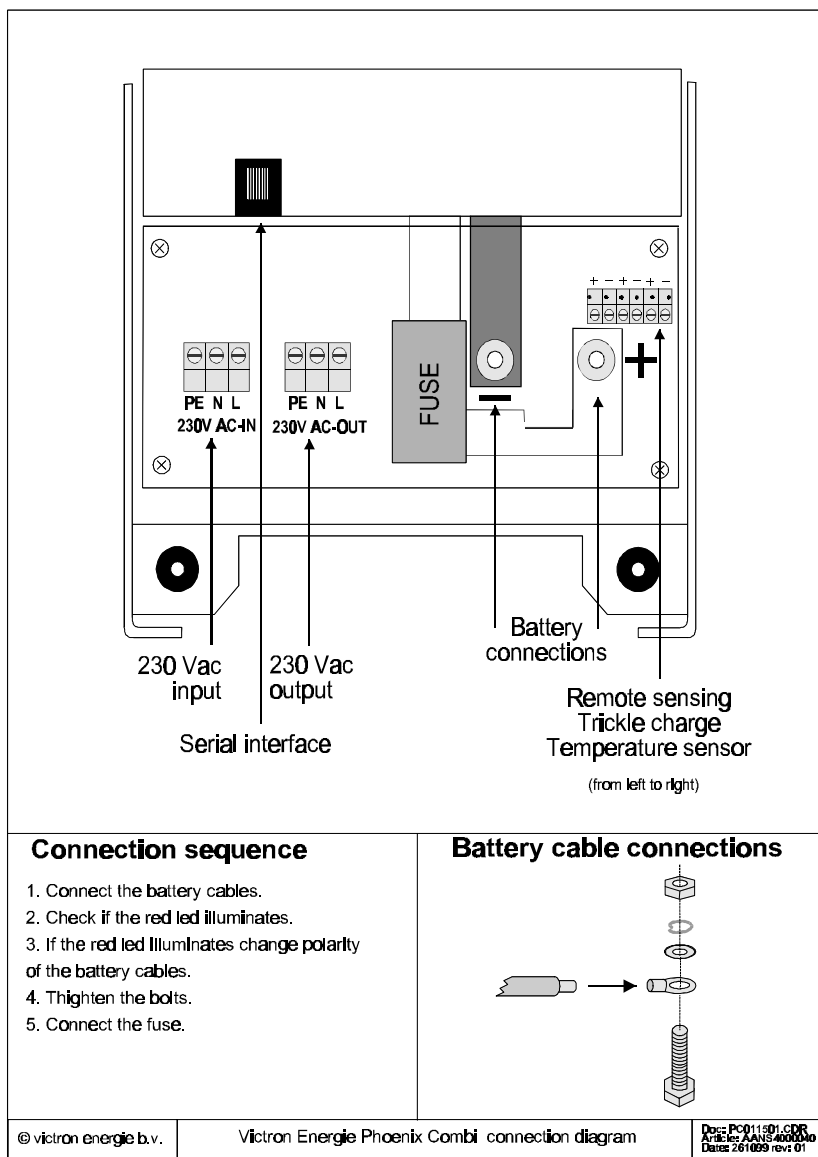

7.3 Parallel connection diagram

